



**800000-pixel IEEE1394 Monochrome CCD Camera**

---

**CS3950DiF**

---

**Specification**

---

**TOSHIBA TELI CORPORATION**

---

# Contents

1. Overview .....	1
2. Features .....	1
3. Components .....	1
4. Specifications .....	2
5. Functions .....	6
6. Timing charts.....	8
7. Model name .....	12
8. Performance Environment.....	13
9. Outline drawing .....	14



---

## Safety Precaution

Before using this product, read these safety precautions carefully. Important information is shown in this Instruction Manual to protect users from bodily injuries and property damage, and to enable them to use the product safely and correctly.

Please be sure to thoroughly understand the meanings of the following signs and symbols before reading the main text that follows, and observe the instructions given herein.

### [Definition of Safety Signs]



Safety Signs	Description
 <b>WARNING</b>	Indicates a potentially hazardous situation that may result in death or serious injury (*1) in the event of improper handling.
 <b>CAUTION</b>	Indicates a potentially hazardous situation that may result in light to moderate injuries (*2) or only in property damage (*3) in the event of improper handling.

Note \*1: "Serious injury" refers to cases of loss of eyesight, wounds, burns (high or low temperature), electric shock, broken bones, poisoning, etc., which leave after-effects or which require hospitalization or a long period of outpatient treatment or cure.

\*2: "Light to moderate injuries" refers to injuries, burns, electric shock etc. that do not require hospitalization or long-term treatment.

\*3: "Property damage" refers to cases of extensive damage involving damage to buildings, equipment, farm animals, pet animals and other belongings.

### [Explanation of Safety Symbols]

Safety Signs	Description
 <b>PROHIBITED</b>	This sign indicates <b>PROHIBITION</b> (Do not). The content of prohibition is shown by a picture or words beside the symbol.
 <b>MANDATORY</b>	This sign indicates <b>MANDATORY ACTION</b> (You are required to do). The content of action is shown by a picture or words beside the symbol.

 **WARNING**



unplug

- **Immediately cease use of the equipment in the event of abnormality or malfunction.**

If abnormal conditions are present, such as smoke, a burning smell, ingress of water or foreign matter, or if the equipment is dropped or malfunctions, fire or electric shock may result.

If such abnormalities occur, disconnect the power plug from the outlet and contact your sales representative.



Do not get wet

- **Do not use the equipment in locations subject to water splashes.**

Otherwise, fire or electric shock may result.



Never pull  
apart

- **Do not disassemble, repair, or modify the equipment.**

Otherwise, fire or electric shock may result.

For internal repair, inspection, or cleaning, contact your sales representative.



Avoid

- **Do not place anything on the equipment.**

If metallic objects, liquid, or other foreign matter enters the equipment, fire or electric shock may result.



Avoid

- **Do not install the equipment in an unstable or inclined location or locations subject to vibration or impact.**

Otherwise, the equipment may topple over and cause personal injury.



Do not touch

- **During an electrical storm, do not touch the power cord or connection cable.**

Otherwise, an electric shock may result.



Instruction

- **Use the specified voltage.**

Use of an unspecified voltage may result in fire or electric shock.



Avoid

- **Do not be handled roughly, damaged, fabricated, bent forcefully, pulled, twisted, bundled, placed under heavy objects or heated the power cord, connection cable.**

Otherwise, fire or electric shock may result.

---

[General Handling]

---

 **CAUTION**



Instruction

- **Observe the following when installing the equipment:**
  - Do not cover the equipment with a cloth, etc.
  - Do not place the equipment in a narrow location where heat is likely to accumulate. Otherwise, heat will accumulate inside the equipment, possibly resulting in a fire.



Avoid

- **Do not place the equipment in locations subject to high moisture, oil fumes, steam, or dust.** Otherwise, fire or electric shock may result.



Avoid

- **Do not install the equipment in locations exposed to direct sunlight or humidity.** Otherwise, the internal temperature of the equipment will rise, which may cause a fire.



Instruction

- **Use only specified DC power cables and connection cables.** Otherwise, fire or electric shock may result.



Instruction

- **When performing connection, turn off power.** When connecting the power cable or connection cable, turn off the equipment power. Otherwise, fire or electric shock may result.



Instruction

- **Contact your sales representative to request periodic inspection and cleaning (every approx. five years).** Accumulation of dust inside the equipment may result in fire or electric shock. For inspection and cleaning costs, contact your sales representative.

---

---

## **CASES FOR INDEMNITY (LIMITED WARRANTY)**

---

We shall be exempted from taking responsibility and held harmless for damage or losses incurred by the user in the following cases.

- In the case damage or losses are caused by fire, earthquake, or other acts of God, acts by a third party, deliberate or accidental misuse by the user, or use under extreme operating conditions.
- In the case of indirect, additional, consequential damages (loss of business interests, suspension of business activities) are incurred as result of malfunction or non-function of the equipment, we shall be exempted from responsibility for such damages.
- In the case damage or losses are caused by failure to observe the information contained in the instructions in this instruction manual and specifications.
- In the case damage or losses are caused by use contrary to the instructions in this instruction manual and specifications.
- In the case damage or losses are caused by malfunction or other problems resulting from use of equipment or software that is not specified.
- In the case damage or losses are caused by repair or modification conducted by the customer or any unauthorized third party (such as an unauthorized service representative).
- Expenses we bear on this product shall be limited to the individual price of the product.
- About the item which does not have a publication in the specifications and manual of this product, it considers as the outside for a guarantee.

---

---

## **RESTRICTION FOR USE**

---

- Should the equipment be used in the following conditions or environments, give consideration to safety measures and inform us of such usage:
    1. Use of the equipment in the conditions or environment contrary to those specified, or use outdoors.
    2. Use of the equipment in applications expected to cause potential hazard to people or property, which require special safety measures to be adopted.
-

---

● This product can be used under diverse operating conditions. Determination of applicability of equipment or devices concerned shall be determined after analysis or testing as necessary by the designer of such equipment or devices, or personnel related to the specifications. Such designer or personnel shall assure the performance and safety of the equipment or devices.

---

● This product is not designed or manufactured to be used for control of equipment directly concerned with human life (\*1) or equipment relating to maintenance of public services/functions involving factors of safety (\*2). Therefore, the product shall not be used for such applications.

(\*1): Equipment directly concerned with human life refers to.

- Medical equipment such as life-support systems, equipment for operating theaters.
- Exhaust control equipment for exhaust gases such as toxic fumes or smoke.
- Equipment mandatory to be installed by various laws and regulations such as the Fire Act or Building Standard Law
- Equipment related to the above

(\*2) :Equipment relating to maintenance of public services/functions involving factors of safety refers to.

- Traffic control systems for air transportation, railways, roads, or marine transportation
  - Equipment for nuclear power generation
  - Equipment related to the above
-

---

---

## Notes on using this product

---

- **Handle carefully**

Do not drop the equipment or allow it to be subject to strong impact or vibration, as such action may cause malfunctions. Further, do not damage the connection cable, since this may cause wire breakage.

---

- **Environmental operating conditions**

Do not use the product in locations where the ambient temperature or humidity exceeds the specifications.

Otherwise, image quality may be degraded or internal components may be adversely affected. In particular, do not use the product in areas exposed to direct sunlight. Moreover, during shooting under high temperatures, vertical stripes or white spots (noise) may be produced, depending on the subject or camera conditions (such as increased gain). However, such phenomena are not malfunctions.

---

- **Check a combination with the lens**

Depending on the lens and lighting you use, an image is reflected as a ghost in the imaging area. However, this is not because of a fault of the camera.

In addition, depending on the lens you use, the performance of the camera may not be brought out fully due to deterioration in resolution and brightness in the peripheral area, aberration and others.

Be sure to check a combination with the camera by using the lens and lightning you actually use.

When installing a lens in the camera, make sure carefully that it is not tilted.

In addition, use a mounting screw free from defects and dirt. Otherwise, the camera may be unable to be removed.

---

- **Do not shoot under intense light.**

Avoid intense light such as spot lights on part of the screen because it may cause blooming or smears. If intense light falls on the screen, vertical stripes may appear on the screen, but this is not a malfunction.

---

- **Occurrence of moiré**

If you shoot thin stripe patterns, moiré patterns (interference fringes) may appear. This is not a malfunction.

---

- **Occurrence of noise on the screen**

If an intense magnetic or electromagnetic field is generated near the camera or connection cable, noise may be generated on the screen. If this occurs, move the camera or the cable.

---

- **Handling of the protective cap**

If the camera is not in use, attach the lens cap to the camera to protect the image pickup surface.

---

- **If the equipment is not to be used for a long duration**

Turn off power to the camera for safety.

---



---

- **Maintenance**

Turn off power to the equipment and wipe it with a dry cloth.

If it becomes severely contaminated, gently wipe the affected areas with a soft cloth dampened with diluted neutral detergent. Never use alcohol, benzene, thinner, or other chemicals because such chemicals may damage or discolor the paint and indications.

If the image pickup surface becomes dusty, contaminated, or scratched, consult your sales representative.

---

- **Disposal**

When disposing of the camera, it may be necessary to disassemble it into separate parts, in accordance with the laws and regulations of your country and/or municipality concerning environmental contamination.

---

**This equipment has been tested and found to comply with the limits for a class A digital device, pursuant to Part 15 of the FCC Rules.**

**These limits are designed to provide reasonable protection against harmful interference when the equipment is operated in a commercial environment.**

**This equipment generates, uses, and can radiate radio frequency energy and, if not installed and used in accordance with the instruction manual, may cause harmful interference to radio communication.**

**Operation of this equipment in a residential area is likely to cause harmful interference in which case the user will be required to correct the interference at his own expense.**

---

# 1. Overview

This CCD camera is a one-body type monochrome camera that adopts all-pixel-data-readout interline CCD that is compatible with the XGA format. For video output, the serial digital bus standard "IEEE1394" is adopted for high transfer rate.

## 2. Features

- **1/3 progressive scan CCD**  
Adopts the square-grid-array, all-pixel-data-readout interline CCD.
- **High frame rate**  
Realizes video output at a high frame rate of 30 frames/second.
- **Random trigger shutter function**  
Equipped with the random trigger shutter function that starts exposure in sync with an external trigger signal and soft trigger to capture an object in high speed at a fixed point for accurate image processing.
- **Scalable mode function**  
Allows faster video output by reading only specified portions of the screen.
- **C-mount**  
Adopts the versatile C-mount standard for the lens mount.
- **IEEE1394 output**  
Performs video output via the serial digital bus standard IEEE 1394 interface. Data transfer is at 400 Mbps that can output uncompressed video data in the XGA (1024 x 768) size at 30 fps.
- **Control using PC**  
Allows the user to browse and control basic information of the camera using the PC. This camera is conforms to the IIDC 1394 digital camera protocol.

## 3. Components

- Camera main body ..... 1
- User's manual (Japanese) ..... 1
- User's manual (English) ..... 1

\* Options

- IEEE1394 cable
- Mounting bracket

---

## 4. Specifications

### [Electrical specifications]

Image sensor	: 1/3 type all-pixel-data-readout interline transfer CCD
Total number of pixels	: 1077 (H) × 788 (V) Approx. 850,000 pixels
Number of effective pixels	: 1034 (H) × 779 (V) Approx. 800,000 pixels
No. of video output effective pixels	: 1024 (H) × 768 (V) Approx. 790,000 pixels
Pixel cell size	: 4.65μm (H) × 4.65μm (V)
Sensitivity	: 400lx, F5.6
Minimum illumination	: 4lx, F1.4 (Gain: Max., approx. 50% of video output)
Gain setting	: The following gain setting is possible using communication commands: GAIN; -6 to +10dB (initial factory setting : 0dB)
Gamma	: Fixed at 1.0
Power supply	: 8 VDC to +30 VDC (supplied via the IEEE1394 cable)
Power consumption	: approx. 2.6W (at +12V)

### [Interface specifications]

Interface method	: Compliant with IEEE Std.1394a-2000
Transfer rate	: 400 Mbps
Video mode	: Format_1 Mode_5 ; 1024×768 Mono 8bit Can be switched between 30, 15, 7.5, and 3.75 fps (factory setting: 30fps) Format_7 Mode_0 (when the scalable function is used)
Protocol	: Compliant with IIDC1394-based Digital Camera Specification Ver.1.31

### [Trigger signal specifications]

(Shutter Trigger)	: $V_L = 0 \sim 0.5V$ $V_H = 2 \sim 5V$ High impedance (100kΩ)
Capture timing	: Can be switched between rising edge/falling edge detection (Factory setting: falling edge detection)
Pulse width	: Minimum : 1μs Maximum : 2s

### [Electronic shutter specifications]

Factory setting	: Electric shutter OFF
Normal electronic shutter	: Set via the IEEE1394 interface * Exposure time can be set up in FIX mode, 32bit Floating-point format mode.
Random trigger shutter	: Set via the IEEE1394 interface * Exposure time can be set up in FIX mode, 32bit Floating-point format mode and pulse width mode.

[Operating ambient specifications]

Performance guarantee temp./humidity	:	0 ~ +40 °C / 30 ~ 70 %RH	(No condensation)
Operating temperature/humidity	:	-5 ~ +45 °C / 30 ~ 90 %RH	(No condensation)
Storage temperature/humidity	:	-20 ~ +60 °C / 10 ~ 90 %RH	(No condensation)

[Mechanical specifications]

Lens mount	:	C-mount
Dimensions	:	Detailed in the outline drawing
Mass	:	Approx. 170 g
Chassis grounding/insulation	:	Between connector shell and FG    Continuity provided
	:	Between FG and SG                    Continuity not provided

**\* Combination of C-mount lens**

As for the C-mount lens used combining this camera, the projection distance from bottom of the screw should use 7.1mm or less.

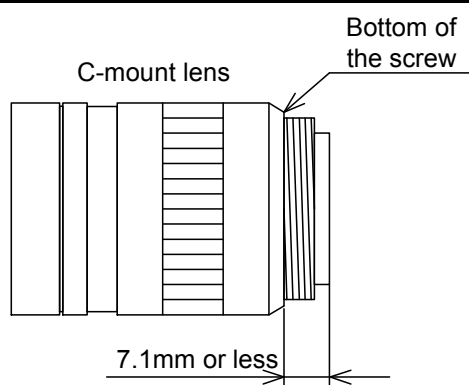

[Typical spectrum response]

The lens characteristics and light source characteristics is not reflected in table.

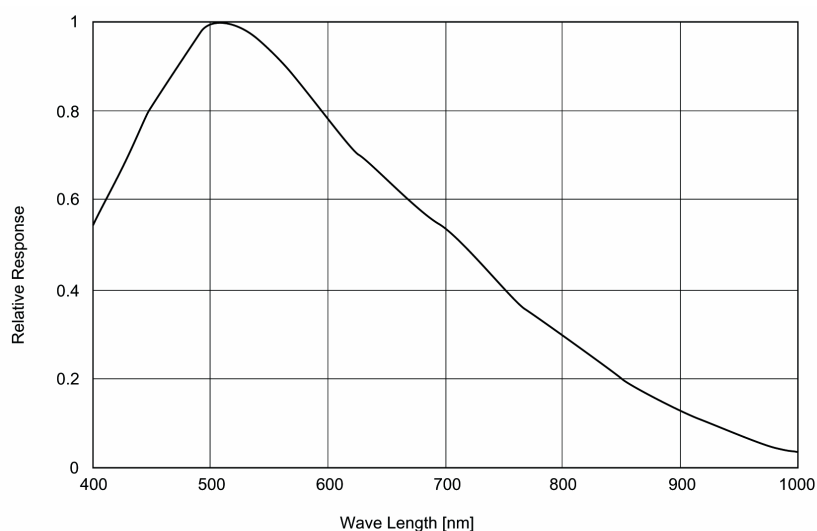

[Applicable safety standards]

EMC (Electro –Magnetic Compatibility)  
EMI (Electro-Magnetic Interference) : EN61000-6-4 / 2001  
EMS (Electro-Magnetic Susceptibility) : EN61000-6-2 / 2001  
FCC : FCC Part15 Subpart B class A

**\* Conformity of EMC conditions**

About the conformity of the EMC standard of this machine, it has guaranteed in the conditions combined with the recommended parts.

When used combining parts other than specification of our company, I ask you to have final EMC conformity checked of a visitor with a machine and the whole equipment.

[Optical black]

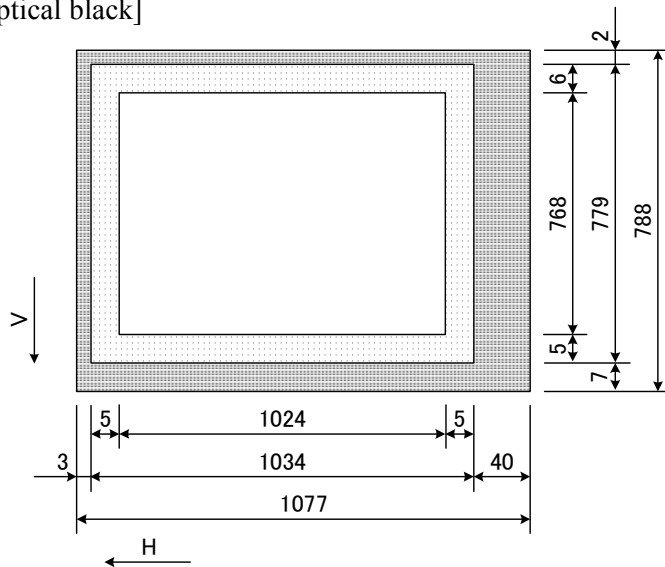

Total number of pixels : 1077 (H) × 788 (V)  
Number of effective pixels : 1034 (H) × 779 (V)  
No. of video output effective pixels : 1024 (H) × 768 (V)

[IEEE1394 connector pin arrangement]

IEEE1394 connector : HSB-ARD62-SN15A (DDK Ltd.)  
 Recommended harness : HSB-HC□-A07 (DDK Ltd.)  
 Pin arrangement : Refer to the table below.

Pin No.	Signal name	I/O	Remark
1	POWER	I	
2	POWER (GND)	I	
3	TPB-	I/O	
4	TPB+	I/O	
5	TPA-	I/O	
6	TPA+	I/O	

[TRIG pin connector]

Connector : HR25-7TR-4PA (Hirose Electric Co., Ltd.)  
 Applicable connector : HR25-7TP-4S (Hirose Electric Co., Ltd.)  
 \* Not attached to this product.  
 Pin arrangement : Refer to the table below.

Pin No.	Signal name	I/O	Remark
1	TRIG	I	
2	TRIG GND	I	
3	NC	—	Used in open
4	NC	—	Used in open

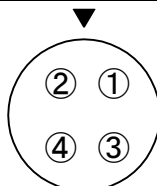

\* The figure above is the camera-side connector seen from the fitting (insert) side.

---

## 5. Functions

- **Gain Control**

This camera adopts the manual gain setting method. The factory setting is 0dB (rated image pickup state). By adjusting the setting value of the command status register of the camera via the IEEE1394 serial bus, you can set the gain in 121 steps in the range between -6 to +10dB. However, the amount of gain change per step is not constant because of the variable characteristic of the gain control amplifier.

- **Shutter mode switching**

You can switch the shutter modes by adjusting the setting value of the command status register of the camera via the IEEE1394 serial bus.

Normal electronic shutter : Performs exposure control via the internal synchronization signal.  
Random trigger shutter : Random trigger shutter can capture images at any timing using the external trigger signal and soft trigger input. It is effective for image input of moving objects and obtaining images of the same timing using multiple cameras.

- **Normal electronic shutter and Random trigger shutter exposure switching**

You can switch the exposure mode of the electronic shutter by adjusting the setting value of the command status register. This camera supports Trigger mode 0 and Trigger mode 1 of the IIDC1394 digital camera protocol. You can switch the exposure mode of the random trigger shutter by adjusting the setting value of the command status register.

FIX mode : The following exposure time can be set via the IEEE1394 serial bus;  
1/100s, 1/250s, 1/500s, 1/1,000s, 1/2,000s, 1/4,000s, 1/10,000s, and 1/20,000s

32bit Floating-point format mode : The following exposure time can be set via the IEEE1394 serial bus;  
Exposure time: 10 $\mu$ s ~ 2s

Exposure time = (-1)\*\* S \* (M+1) \* 2\*\*(E-127) [sec]

Sign (S)	Exponent (E)	Mantissa (M)
1bit	8bit	23bit

Pulse width mode(Only Random trigger shutter)

: The exposure time can be controlled by the TRIG signal pulse width.

Pulse width : 1 $\mu$ s ~ 2s

- **Video output mode**

1/30s non-interlace mode

All pixels are read in 1/30s, so video image in high vertical resolution can be obtained.

- **Scalable mode**

This camera has the scalable mode that can read out defined area of the screen. The horizontal and vertical minimum unit sizes, at  $32 \times 24$  pixels, both represent a 32-part split of total screen horizontal and vertical sizes. A read out area can be designed by start address (i, j). However, specify an address by every 4 pixels. Only continuous square units can be selected, concave or convex shape cannot be selected.

Window of  $32 \times 24$  pixels per unit :  $32 * m(H) \times 24 * n(V)$  (m/n = An integer: 1,2,3,4...32)

Selectable the video of  $1024 \times 768$  (maximum)

Up to 1 window

Start address

:  $4 * i(H) \times 4 * j(V)$

(i = integer: 0,1,2,3,...248)

(j = integer: 0, 1, 2,...186)

A window is in the screen



In the scalable mode, this camera reads out only the necessary portions at the standard speed while it scans through other unnecessary portions at high speed, so the trigger interval can be shorter if the vertical cutout width is small. However, the trigger interval cannot be short in the horizontal direction even if the cutout width is small due to the operation mechanism of the CCD sensor.

**Notice**

White lines may occur in the upper portions of the screen when strong light exists in a wide area during the scalable mode. This is not a malfunction. If white lines occur, adjust the amount of incident light using the lens.



## 6. Timing charts

For video data output of this camera, Isochronous transmission of IEEE1394 is used. For the timing values defined below, a necessary condition is that this camera can use the isochronous band without any restriction from other node. If any node is performing Isochronous transmission on the IEEE1394 local bus concurrently with this camera, the values are not a defined below.

### • Format1\_mode5

[Electronic Shutter OFF]

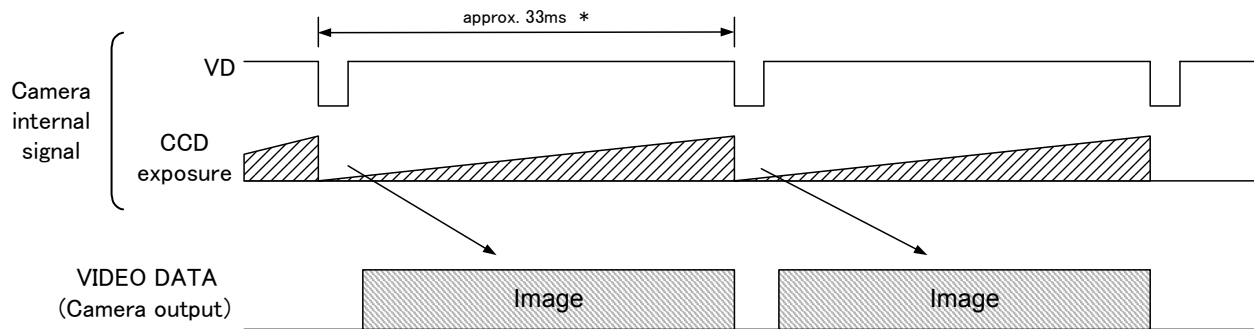

\* At frame rate 30fps. 15fps : approx. 66.7ms, 7.5fps : approx. 133ms, 3.75fps : approx. 266.7ms.

[ Electronic shutter mode,  $33\text{ms}^* \geq \text{Exposure time}$ ]

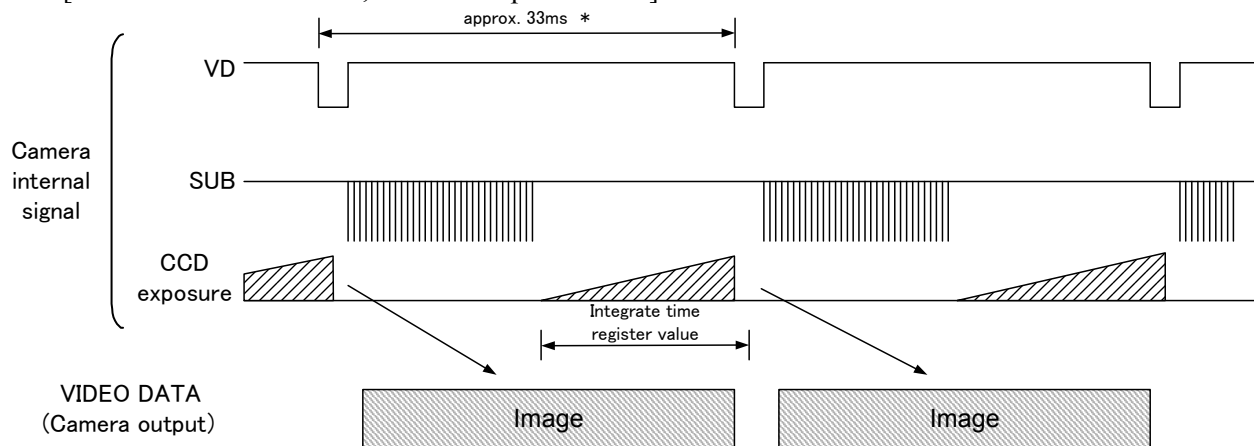

\* At frame rate 30fps. 15fps : approx. 66.7ms, 7.5fps : approx. 133ms, 3.75fps : approx. 266.7ms.

[Electronic shutter mode,  $33\text{ms}^* < \text{Exposure time}$ ]

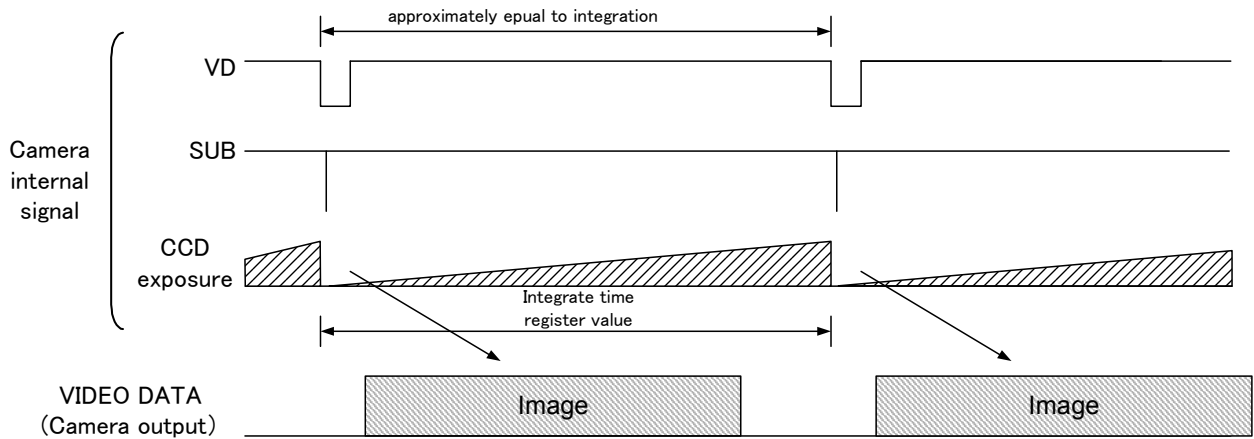

\* At frame rate 30fps. 15fps : approx. 66.7ms, 7.5fps : approx. 133ms, 3.75fps : approx. 266.7ms.

[Electronic shutter mode, Random trigger shutter mode, Exposure time: Register Value control]

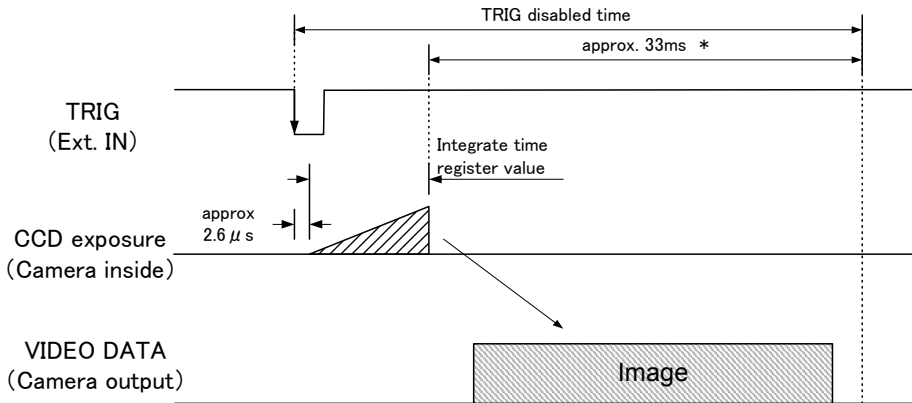

\* At frame rate 30fps. 15fps : approx. 66.7ms, 7.5fps : approx. 133ms, 3.75fps : approx. 266.7ms.

[Electronic shutter mode, Random trigger shutter mode, Exposure time: Pulse width control]

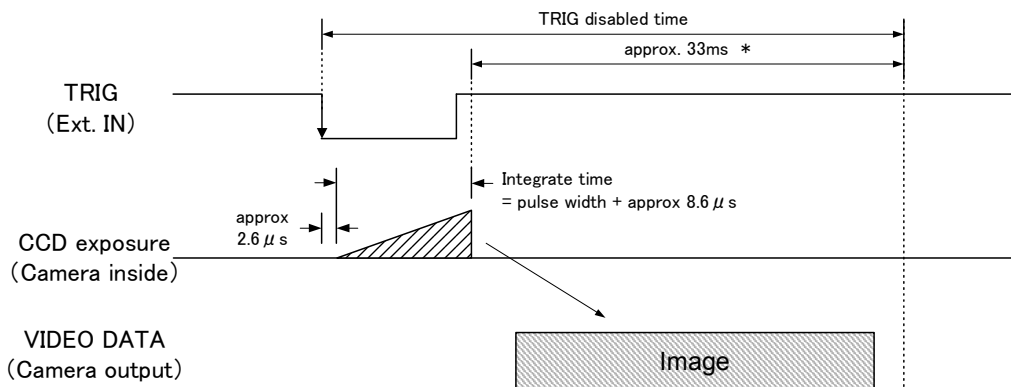

\* At frame rate 30fps. 15fps : approx. 66.7ms, 7.5fps : approx. 133ms, 3.75fps : approx. 266.7ms.

• **Format7\_mode0**

[Electronic Shutter OFF]

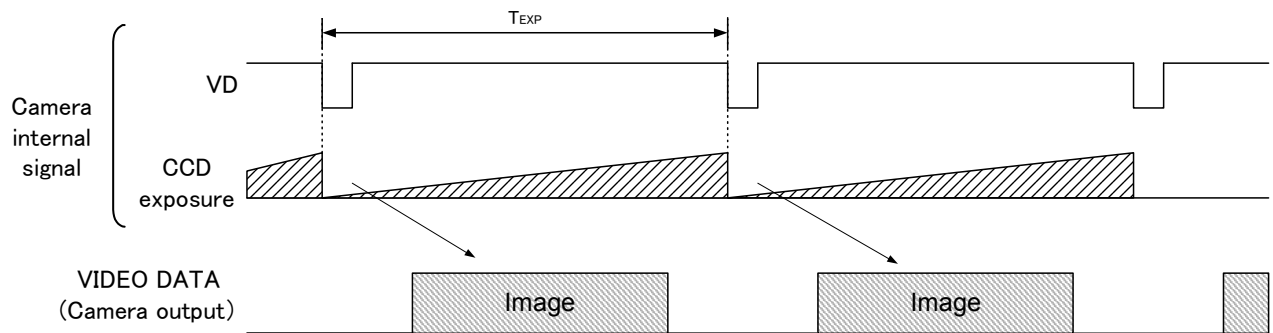

\* Please refer to "Calculation of Frame Rate in Format\_7" of the Application manual for the  $T_{EXP}$ .

[ Electronic shutter mode,  $T_{EXP} \geq$  Exposure time]

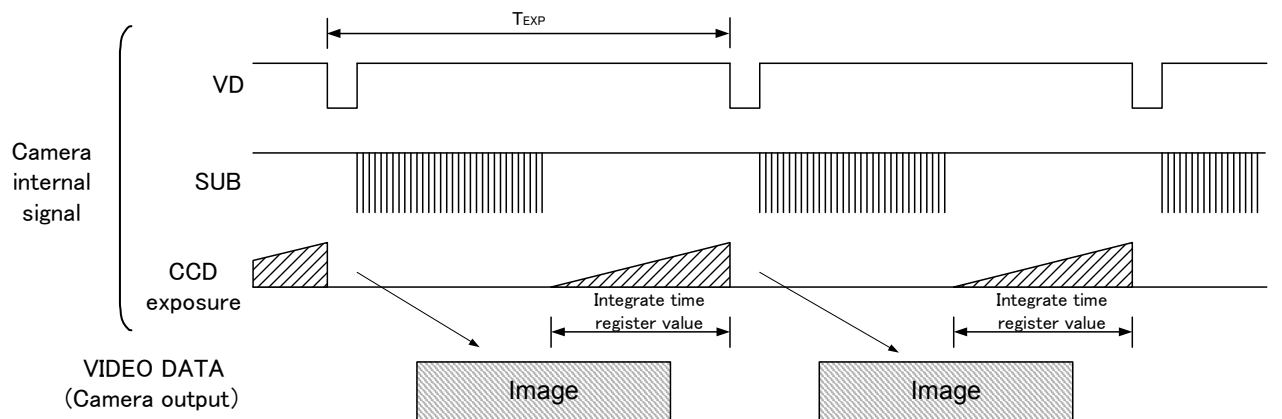

\* Please refer to "Calculation of Frame Rate in Format\_7" of the Application manual for the  $T_{EXP}$ .

[Electronic shutter mode,  $T_{EXP} <$  Exposure time]

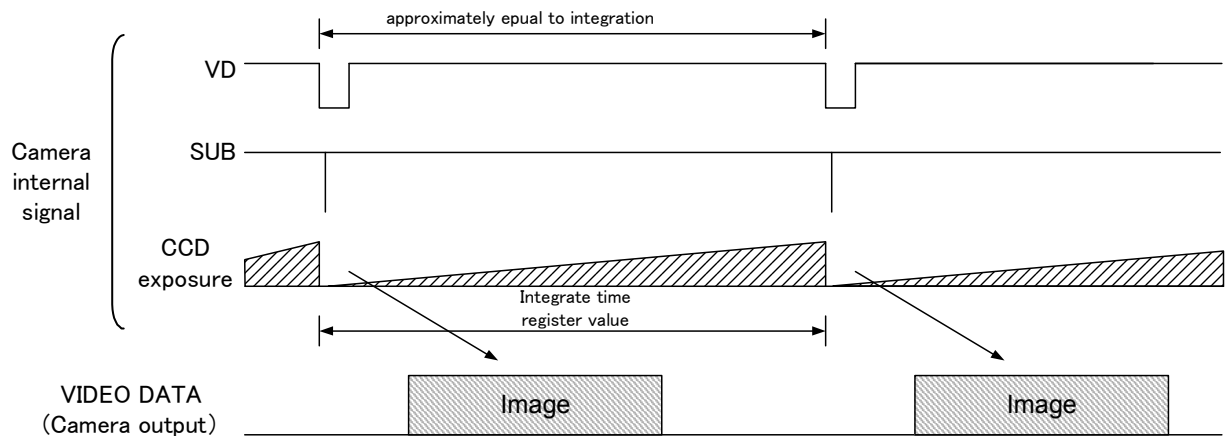

[Electronic shutter mode, Random trigger shutter mode, Exposure time: Register Value control]

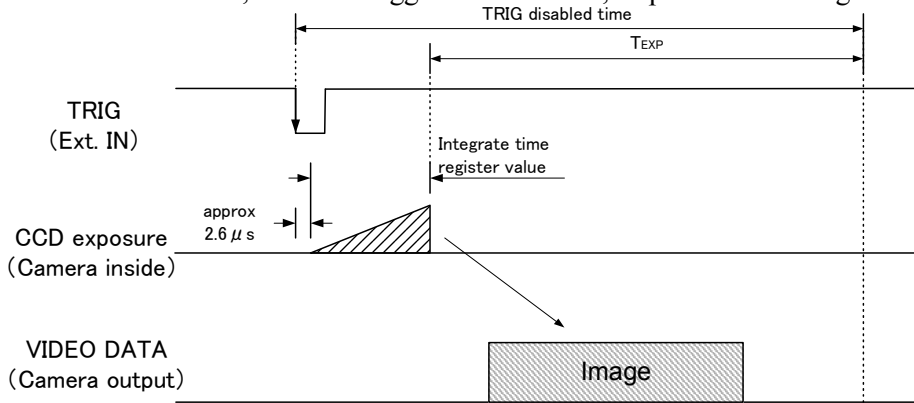

\* Please refer to "Calculation of Frame Rate in Format\_7" of the Application manual for the  $T_{EXP}$ .

[Electronic shutter mode, Random trigger shutter mode, Exposure time: Pulse width control]

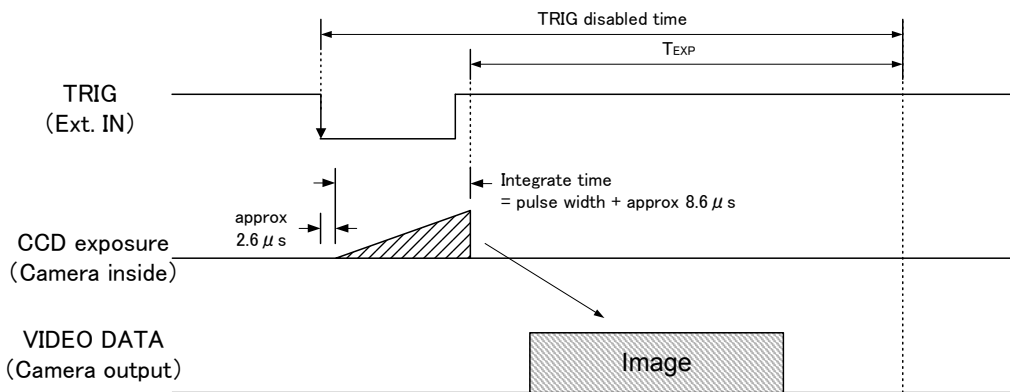

\* Please refer to "Calculation of Frame Rate in Format\_7" of the Application manual for the  $T_{EXP}$ .

\* **Random trigger shutter exposure delay time**

In the random trigger shutter mode, there is an exposure delay time of approx.  $2.6 \mu s$  from the falling edge of the TRIG signal to the start of exposure in both the FIX mode and pulse width mode.

\* **Pulse width mode exposure time**

In the random trigger shutter and pulse width modes, the exposure time is determined depending on the pulse width, but the actual exposure time is pulse width +  $8.6 \mu s$ .

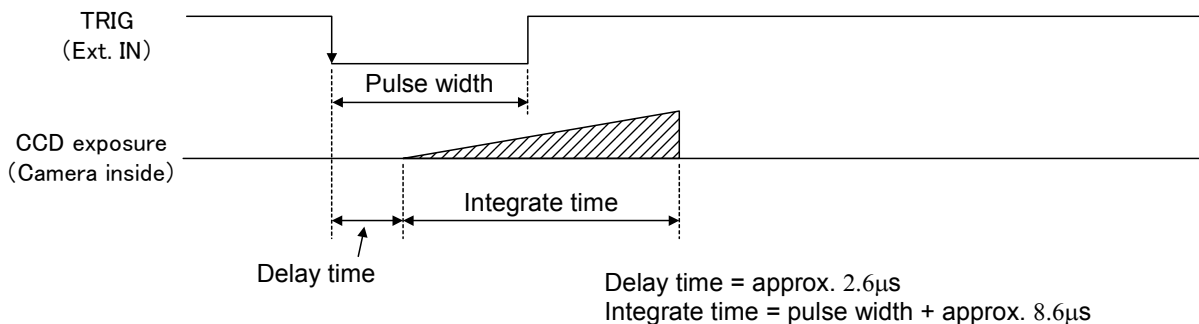

\* TRIGGER Polarity:Negative

## 7. Model name

The model names of this camera are represented as follows (the details are changed when a model name changes).

### (1) Camera internal register

The serial number and model name of the camera are controlled in the configuration ROM register installed in the camera in the following format.

**Node Unique ID leaf**

	Offset	0-7	8-15	16-23	24-31
Node unique ID leaf	0000h	0002h		CRC (CRC only for this leaf)	
	0004h	node_vendor_id			chip_id_hi
	0008h	chip_id_lo			

The details of Node unique ID leaf are described as follows:

Node\_vendor\_id : Manufacturer (company) ID registered to IEEE is written. Manufacturer ID is H'000600 in hexadecimal notation.  
 chip\_id\_hi : H'00 is written to identify the model.  
 chip\_id\_lo : H'04 is written in the upper 1 byte to identify the model. The serial number to identify the individual unit is written in the lower 3 bytes. The possible values are 0 to 16,777,215, however, 7-digit values from 1 to 9,999,999 in decimal notation (H'1 to H'98967F in hexadecimal) are used as serial numbers.

The following results are obtained when Node unique ID leaf is referred to.

0000h : 0002xxxx (xxxx varies for different units because of CRC.)  
 0004h : 00060000  
 0008h : 04yyyyyy (yyyyyy is the manufacturing number)

**Vendor / Model Name Leaves**

	Offset	0-7	8-15	16-23	24-31	
Name leaf	0000h	leaf_length		CRC (CRC only for this leaf)		
	0004h	00	00	00	00	
	0008h	00	00	00	00	
	000Ch	char_0	char_1	char_2	char_3	
	0010h	char_4	char_5	char_6	char_7	
	0014h	char_8				
	n+6h					
	n+Ah	char_n-2	char_n-1	NUL	NUL	

ASCII representation

The vendor name and mode name information is stored in ASCII code. For the offset of this leaf, each address must be obtained from vendor\_name\_leaf / model name leaf of Unit Depend Directory...

Vendor names are as shown below.

**Vendor Name Leaf**

	Offset	0-7	8-15	16-23	24-31
Vendor Name leaf	0000h	0003		CRC (CRC only for this leaf)	
	0004h	00	00	00	00
	0008h	00	00	00	00
	000Ch	'T'	'E'	'L'	'I'

ASCII representation

Model names are shown below.

**Model Name Leaf**

	Offset	0-7	8-15	16-23	24-31
Name leaf	0000h	leaf_length		CRC (CRC only for this leaf)	
	0004h	00	00	00	00
	0008h	00	00	00	00
	000Ch	'C'	'S'	'3'	'9'
	0010h	'5'	'0'	'D'	'i'
	0014h	'F'	SP(0x20)	'V'	*
	0018h	*	*	NUL	NUL

ASCII representation

\* indicates the version of the firmware (ASCII representation: 0x30 to 0x39).

## 8. Performance Environment

The verification test for CS3950DiF is performed under the following condition. Some satisfactory specifications and adequate performances might not be obtained in the difference condition. Determination of applicability of equipment or devices concerned shall be determined after analysis or testing as necessary by the designer of such equipment or devices, or personnel related to the specifications. Such designer or personnel shall assure the performance and safety of the equipment or devices.

- |                    |   |
|--------------------|---|
| (1) 1394- PCI card | PFW-41 (Manufactured by technoscope)                  |
| (2) PC Environment |   |
| CPU                | Pentium III 1GHz                                      |
| M/B                | Intel 82801BA LPC                                     |
| PCI bus            | PCI Ver. 2.1 compatible / Support to BusMaster system |
| Memory             | 512MB   |
| OS                 | Windows2000   |

# 9. Outline drawing

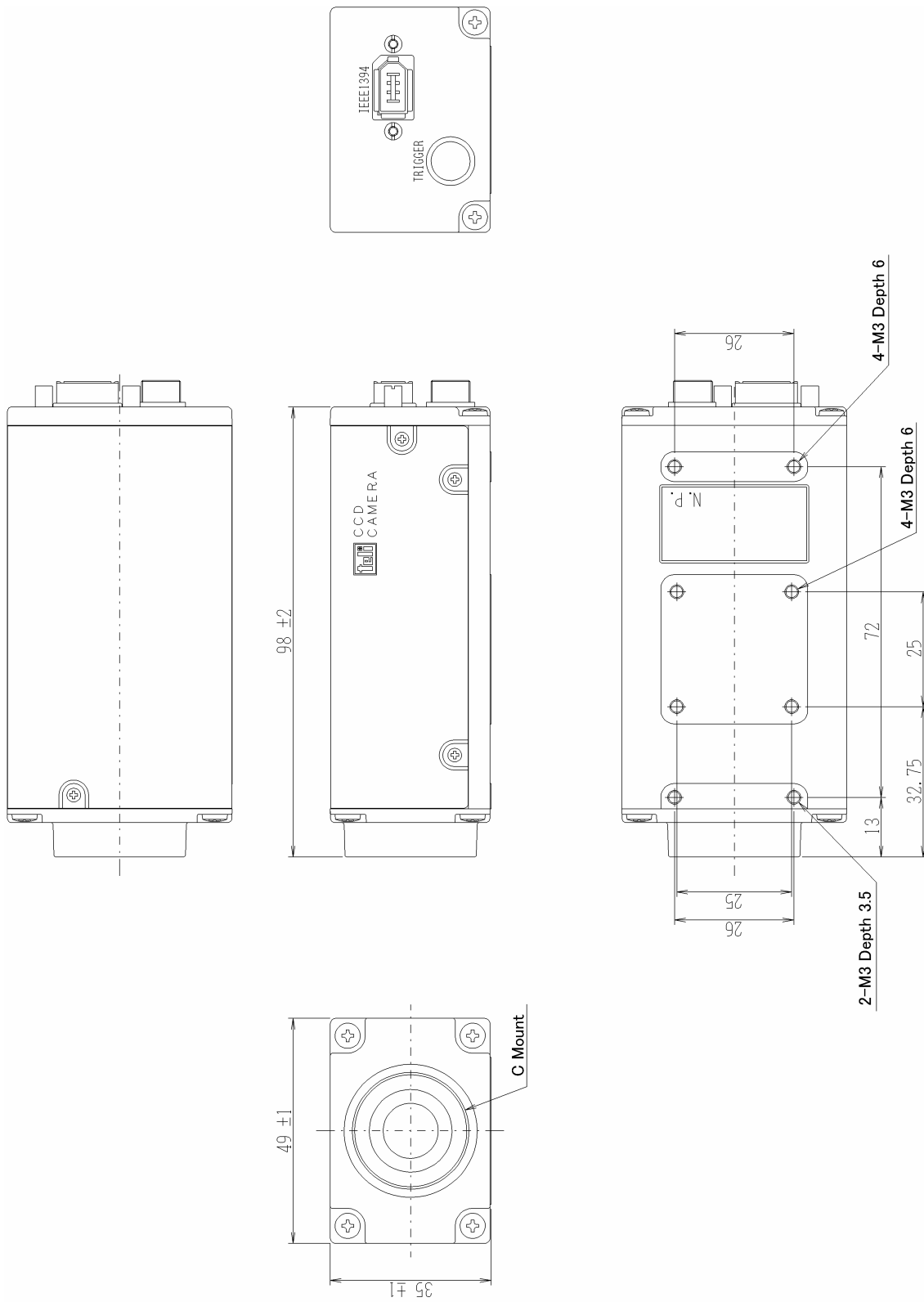

\* The trigger cable and IEEE1394 cable are not included in the scope of supply.



---

## **TOSHIBA TELI CORPORATION**

---

**Head Office** : 7-1, 4 chome, Asahigaoka, Hino-shi, Tokyo, 191-0065, Japan  
(Overseas Sales Department)

Phone : +81-42-589-8771

Fax : +81-42-589-8774

URL : <http://www.toshiba-teli.co.jp>

---

<p><b>Distributor</b></p>
---------------------------

- This product must be classified for disposal according to the laws of each country and municipal laws.
  - Information contained in this document is subject to change without prior notice.
-